

TOWER KAOS 40 MKII



WARRANTY

Tower Hobbies® guarantees this kit to be free from defects in both material and workmanship at the date of purchase. This warranty does not cover any component parts damaged by use or modification. **In no case shall Tower Hobbies' liability exceed the original cost of the purchased kit.** Further, Tower Hobbies reserves the right to change or modify this warranty without notice.

In that Tower Hobbies has no control over the final assembly or material used for final assembly, no liability shall be assumed nor accepted for any damage resulting from the use by the user of the final user-assembled product. By the act of using the user-assembled product, the user accepts all resulting liability.

If the buyer is not prepared to accept the liability associated with the use of this product, the buyer is advised to return this kit immediately in new and unused condition to the place of purchase.

READ THROUGH THIS MANUAL COMPLETELY BEFORE STARTING CONSTRUCTION. IT CONTAINS IMPORTANT INSTRUCTIONS AND WARNINGS CONCERNING THE ASSEMBLY AND USE OF THIS MODEL.



Tower Hobbies
P.O. Box 9078
Champaign, IL 61826
(800) 637-6050
www.towerhobbies.com

TABLE OF CONTENTS

INTRODUCTION	2
SAFETY PRECAUTIONS	2
ADDITIONAL ITEMS REQUIRED	3
Hardware & Accessories.....	3
Optional Supplies & Tools.....	3
IMPORTANT BUILDING NOTES	3
KIT INSPECTION	3
ORDERING REPLACEMENT PARTS.....	3
PARTS LIST	4
INCH/METRIC RULER	4
PREPARATIONS	5
BUILD THE WING	5
Install the Ailerons.....	5
Join the Wings.....	6
Install the Main Landing Gear	8
Install the Aileron Servo	9
ASSEMBLE THE FUSELAGE.....	10
Mount the Stab & Fin	10
Install the Nose Gear.....	12
Install the Fuel Tank & Engine	14
Install the Radio & Servos.....	15
GET THE MODEL READY TO FLY	19
Check the Control Directions	19
Set the Control Throws	19
Balance the Model (C.G.).....	19
Balance the Model Laterally	20
PREFLIGHT	20
Identify Your Model	20
Charge the Batteries	20
Balance the Propellers.....	21
Ground Check.....	21
Range Check	21
ENGINE SAFETY PRECAUTIONS	21
AMA SAFETY CODE (excerpt)	21
CHECK LIST	22
FLYING	22
Takeoff.....	23
Flight.....	23
Landing.....	23

INTRODUCTION

Congratulations and thank you for purchasing the Tower Kaos .40 ARF. You've made the right choice getting this updated version of a classic, all-time favorite of modelers around the world. The Tower Kaos is a stable, forgiving airplane with the capability of performing many popular aerobatics. We hope you enjoy the airplane as much as we have enjoyed bringing it to you!

PROTECT YOUR MODEL, YOURSELF & OTHERS...FOLLOW THESE IMPORTANT SAFETY PRECAUTIONS

1. Your Tower Kaos .40 ARF should not be considered a toy, but rather a sophisticated, working model that functions very much like a full-size airplane. Because of its performance capabilities, the Kaos, if not assembled and operated correctly, could possibly cause injury to you or spectators and damage to property.
2. You must assemble the model **according to the instructions**. Do not alter or modify the model, as doing so may result in an unsafe or unflyable model. In a few cases the instructions may differ slightly from the photos. In those instances the written instructions should be considered as correct.
3. You must take time to **build straight, true and strong**.
4. You must use an R/C radio system that is in first-class condition, and a correctly sized engine and components (fuel tank, wheels, etc.) throughout the building process.
5. You must correctly install all R/C and other components so that the model operates correctly on the ground and in the air.
6. You must check the operation of the model before **every** flight to insure that all equipment is operating and that the model has remained structurally sound. Be sure to check clevises or other connectors often and replace them if they show any signs of wear or fatigue.
7. If you are not already an experienced R/C pilot, you should fly the model only with the help of a competent, experienced R/C pilot.

We, as the kit manufacturer, provide you with a top quality, thoroughly tested kit and instructions, but ultimately the quality and flyability of your finished model depends on how you build it; therefore, we cannot in any way guarantee the performance of your completed model, and no representations are expressed or implied as to the performance or safety of your completed model.

Remember: Take your time and follow the instructions to end up with a well-built model that is straight and true.

If you have not flown this type of model before, we recommend that you get the assistance of an experienced pilot in your R/C club for your first flights. If you're not a member of a club, your local hobby shop has information about clubs in your area whose membership includes experienced pilots.

In addition to joining an R/C club, we strongly recommend you join the AMA (Academy of Model Aeronautics). AMA

membership is required to fly at AMA sanctioned clubs. There are over 2,500 AMA chartered clubs across the country. Among other benefits, the AMA provides insurance to its members who fly at sanctioned sites and events. Additionally, training programs and instructors are available at AMA club sites to help you get started the right way. Contact the AMA at the address or toll-free phone number below:



Academy of Model Aeronautics

5151 East Memorial Drive
Muncie, IN 47302-9252
Tele. (800) 435-9262
Fax (765) 741-0057
Or via the Internet at:
<http://www.modelaircraft.org>

ADDITIONAL ITEMS REQUIRED

In addition to common household tools and hobby tools, this is the "short list" of the most important items required to build the Tower Hobbies Kaos .40. **Tower Hobbies Build-it™ CA and Epoxy glue are recommended.**

HARDWARE & ACCESSORIES

- Four-channel radio with four standard servos.
- The recommended engine size range for the Tower Kaos .40 is .40 - .46 cu in [6.5 - 7.5cc] two-stroke or .48 - .70 cu in [8 - 11.5] four-stroke.
- 6" [150mm] servo extension (HCAM2701 for Futaba®)
- 1/4" [6mm] R/C foam rubber (HCAQ1000)
- 3' [900mm] standard silicone fuel tubing (GPMQ4131)
- 2 oz. Tower Hobbies Build-it Thin CA (TOWR3800)
- 2 oz. Tower Hobbies Build-it Medium CA+ (TOWR3801)
- Tower Hobbies Build-it 30-minute epoxy (TOWR3811)
- Drill bits: 1/16" [1.6mm], 5/64 [2mm], 3/32" [2.5mm], 5/32" [4mm]
- T-pins (HCAR5100)
- #1 Hobby knife (TOWR1010)
- #11 blades (5-pack, TOWR1015)

OPTIONAL SUPPLIES & TOOLS

- Stick-on segmented lead weights (GPMQ4485)
- Top Flite® MonoKote® trim seal iron (TOPR2200)
- Top Flite MonoKote heat gun (TOPR2000)
- 2 oz. Tower Hobbies spray CA activator (TOWR3804)
- Masking tape (TOPR8018)
- Threadlocker™ thread-locking cement (GPMR6060)
- Denatured alcohol (for epoxy clean up)
- AccuThrow™ Deflection Gauge (GPMR2405)

- CG Machine™ (GPMR2400)
- Robart Super Stand II (ROBQ1402)

IMPORTANT BUILDING NOTES

- When you see the **term test** fit in the instructions, it means that you should first position the part on the assembly **without using any glue**, then slightly modify or *custom fit* the part as necessary for the best fit.
- Whenever the term **glue** is written you should rely upon your experience to decide what type of glue to use. When a specific type of adhesive works best for that step, the instructions will make a recommendation.
- Whenever just **epoxy** is specified you may use **either** 30-minute (or 45-minute) epoxy **or** 6-minute epoxy. When 30-minute epoxy is specified it is **highly** recommended that you use only 30-minute (or 45-minute) epoxy, because you will need the working time and/or the additional strength.
- **Photos and sketches** are placed **before** the step they refer to. Frequently you can study photos in following steps to get another view of the same parts.

KIT INSPECTION

Before starting to build, take an inventory of this kit to make sure it is complete, and inspect the parts to make sure they are of acceptable quality. If any parts are missing or are not of acceptable quality, or if you need assistance with assembly, contact **Order Assistance**. When reporting defective or missing parts, use the part names exactly as they are written in the "**Ordering Replacement Parts**" section on this page.

Order Assistance:

Telephone: (800) 637-6050

Fax: (217) 398-7721

E-mail: airsupport@towerhobbies.com

ORDERING REPLACEMENT PARTS

Replacement parts are available from Tower Hobbies for your Tower Kaos .40 ARF. Our order assistance representatives are ready to answer or place your order. Call us at (800) 637-6050.

Replacement Parts

Wing Set - TOWA6010

Fuselage Set - TOWA6011

Tail Set - TOWA6012

Landing Gear Set - TOWA6013

Canopy - TOWA6014

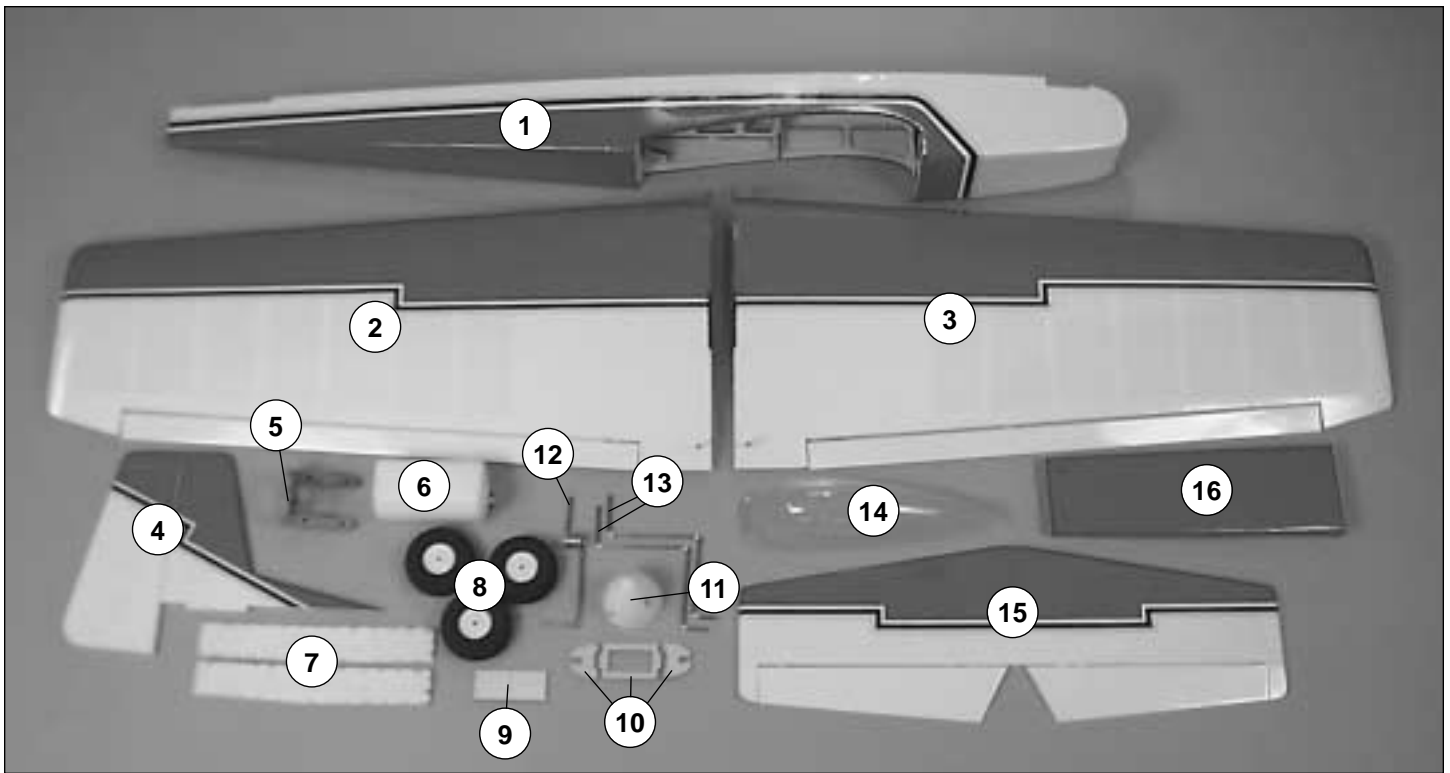

PARTS LIST

1 Fuselage	9 Wing Bolt Block
2 Left Wing Panel w/Aileron	10 Aileron Servo Tray (3 pcs.)
3 Right Wing Panel W/Aileron	11 Spinner
4 Fin/Rudder	12 Nose Landing Gear
5 Engine Mount	13 Main landing Gear
6 Fuel Tank	14 Canopy
7 Wing Joiners (2 pcs.)	15 Stabilizer/Elevator
8 Wheels 2-1/2" (3)	16 Belly Pan

Parts Not Photographed

(15) Hinge material disks	(10) 4mm Wheel collars	(6) 4mm Blind nuts (pre-installed in the firewall and wing bolt mounting plate)
(6) Nylon clevises	(4) 4mm Nuts	(3) 560mm Plastic pushrod tubes (pre-installed in fuselage)
(6) Silicone clevis keepers	(2) Screw-lock connector	(2) 356mm Plastic pushrod tube
(1) Nylon nose gear bearing	(2) Motor mount straps	(3) 2 x 680mm Pushrod wire, threaded one end
(3) Control horns	(6) 2 x 15mm Phillips head machine screws	(2) 2 x 400mm Pushrod wire, threaded one end
(3) Control horn plates	(12) 2 x 10mm Servo mounting screws with washer head	(1) 405mm Wire pushrod with Z-bend on one end
(4) Nylon landing gear straps	(8) 4mm Lock washer	(2) 2 x 155mm Pushrod, threaded one end
(2) Nylon aileron torque rod links	(8) 4mm Flat washer	
(4) Nylon pushrod keepers	(2) Nuts for screw-lock connector	
(2) 4 x 40mm Phillips head machine screws	(2) 4mm Flat washer (large)	
(4) 4 x 25mm Phillips head machine screws	(1) 3 x 10mm Phillips head machine screws	
(6) 4 x 15mm Phillips head machine screws	(12) 3 x 5mm Phillips head machine screws	

To convert inches to millimeters, multiply inches by 25.4 (25.4mm = 1")

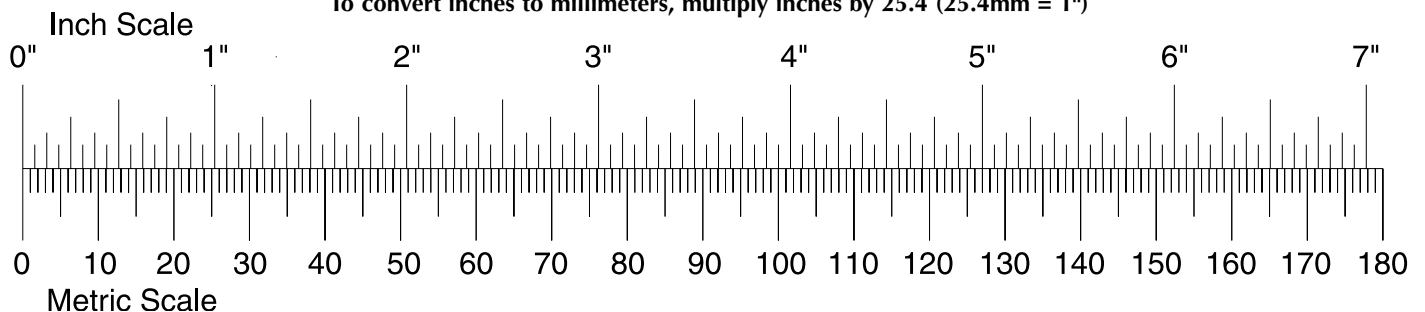

PREPARATIONS

○ 1. If you have not done so already, remove the major parts of the kit from the box and inspect for damage. If any parts are damaged or missing, contact Order Assistance at the telephone number listed in the “**Kit Inspection**” section on page 3.

○ 2. Remove the tape and separate the ailerons from the wing and the elevators from the stab. Use a covering iron with a covering sock on high heat to tighten the covering if necessary. Apply pressure over sheeted areas to **thoroughly** bond the covering to the wood.

BUILD THE WING

INSTALL THE AILERONS

Do the right wing first so your work matches the photos the first time through. You can do one wing at a time, or work on them together.

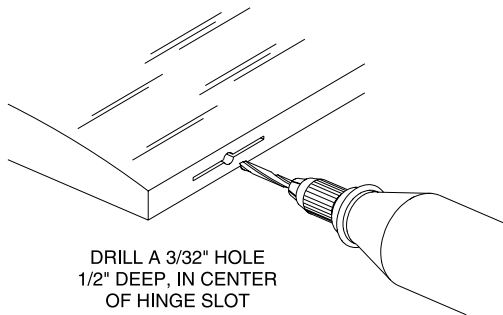

○○ 1. Drill a 3/32" [2.4mm] hole, 1/2" [13mm] deep in the center of each hinge slot to allow the CA to “wick” in. Follow-up with a #11 blade to clean out the slots. **Hint:** If you have one, use a high-speed rotary tool to drill the holes.

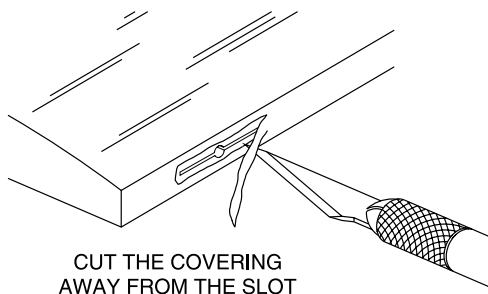

○○ 2. Use a sharp #11 blade to cut a strip of covering from the hinge slots.

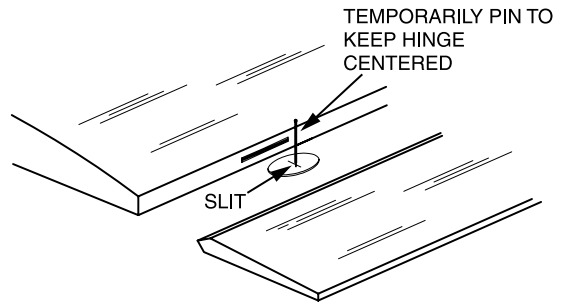

○○ 3. Locate four of the circular **hinge material disks**. Look closely at the disk and you will see a slit cut through the center of the disk. This slit will aid in wicking the glue into the hinge. It is important that the slit in the disk runs perpendicular to the control surface. Insert a pin through the middle of each hinge disk, just off of the slit. Test fit the ailerons to the wing with the hinges installed.

○○ 4. Remove the aileron from the wing. Work some 6-minute epoxy into the hole for the aileron torque rod located at the inboard end of the aileron. Working quickly, install the aileron with the hinges in place back onto the wing. Clean any excess epoxy away from the hole with rubbing alcohol.

○○ 5. Remove the pins you have inserted into the hinges. Adjust the aileron so there is a small gap between the LE of the aileron and the wing. The gap should be small, just enough to see light through or to slip a piece of paper through.



○○ 6. Apply six drops of thin CA to the top and bottom of each hinge. Do not use CA accelerator. After the CA has fully hardened test the hinges by pulling on the aileron.

○ 7. Repeat steps 1-6 for the left wing panel.

JOIN THE WINGS

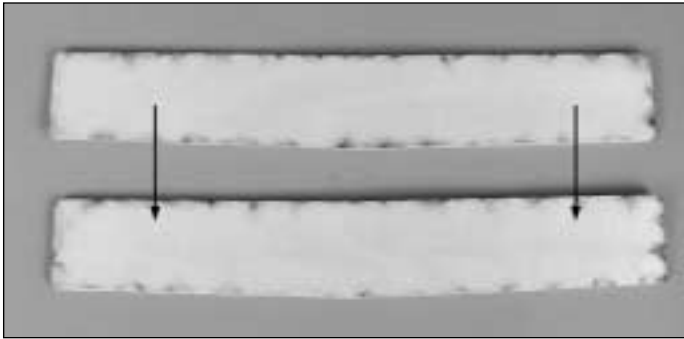

○ 1. Locate the two plywood **wing joiners**. Using 6-minute epoxy, glue the joiners together.

○ 2. Test fit the wing joiner into the wing joiner pocket in each wing half. Sand the joiner as needed until it fits easily into the pockets. There should be enough room in the pocket to allow the glue to contact the entire joiner surface when inserted into the pocket.

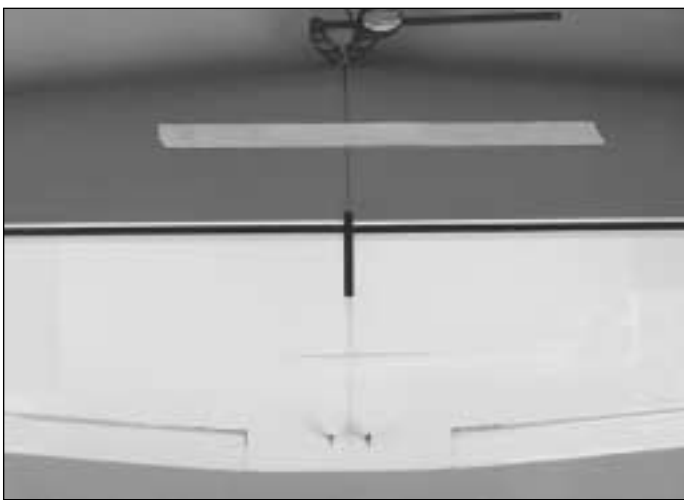

○ 3. Once you are satisfied with the fit, apply a liberal amount of 30-minute epoxy into each wing joiner pocket, on both sides of the wing joiner and the root ribs of both wing halves. Clamp the leading edge of the wing and use masking tape to hold the wing together until the epoxy has cured. Be certain the leading and trailing edges of both wing halves accurately align.

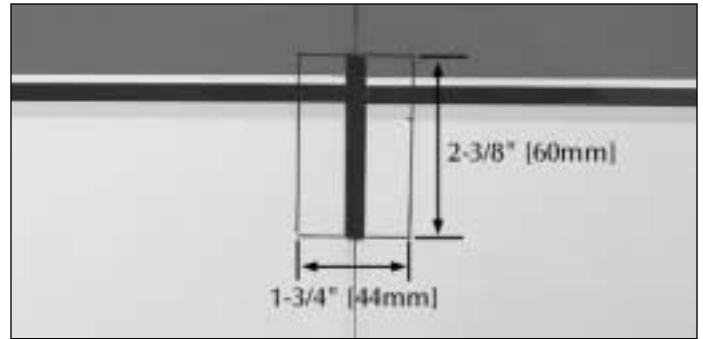

○ 4. Using a felt-tip pen, mark a box 1-3/4" x 2-3/8" [44 x 60mm].



○ 5. Cut through the sheeting on the lines you have drawn with a hobby knife. Remove the sheeting.

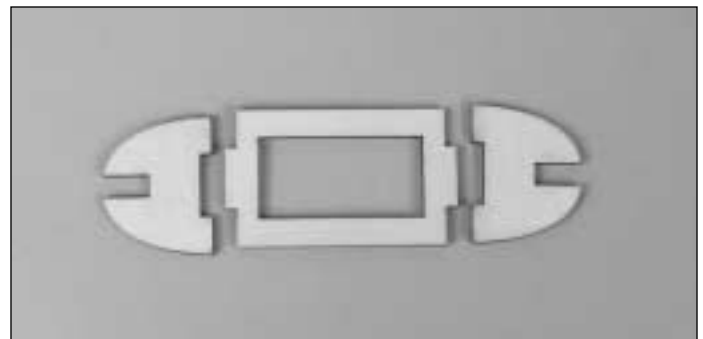

○ 6. Locate the die-cut plywood **servo tray** and **servo tray sides**. Test fit the servo tray sides into the wing cavity. The notch in the bottom of the servo tray sides will fit over the root rib of the wings. Sand the notch as needed to get a good fit. When you are satisfied with the fit, glue the servo tray and sides together.



○ 7. Glue the servo tray into the wing with 6-minute epoxy.

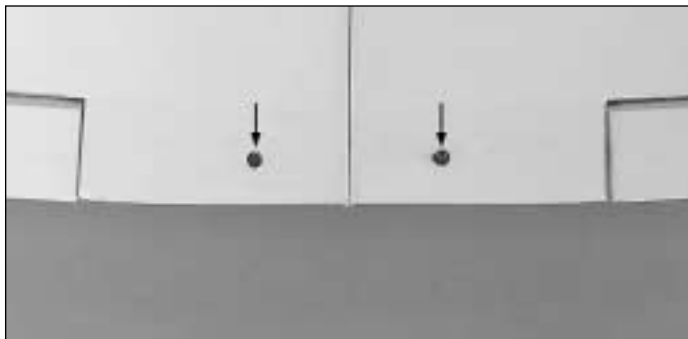

○ 8. Locate the two holes under the covering at the trailing edge of the wing. Cut the covering away on both the top and the bottom of the wing.

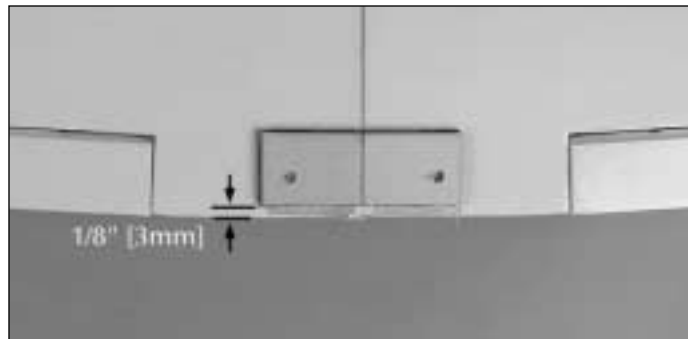

○ 10. Glue the plywood wing bolt plate onto the bottom of the wing over the area where you removed the covering. When gluing it in position, be sure that the plate is set back 1/8" [3mm] from the trailing edge of the wing. Once the glue has cured use a 5/32" [4mm] drill bit to drill through the wing bolt holes from the top of the wing through the wing bolt plates.



○ 9. Locate the plywood **wing bolt plate**. Position it on the bottom of the wing over the wing bolt holes. Using a felt tip marker, trace around the wing bolt plate. Using your modeling knife with a sharp blade, cut the covering away, being careful **not to cut** into the surface of the wing skin. Cutting into the wing skin will weaken the structure. The following tip is an alternative method for safely cutting the covering.



○ 11. Temporarily bolt the wing to the fuselage with two 4 x 40mm bolts and two 4mm washers.



Expert Tip

How to cut covering from balsa.

To avoid cutting into the balsa, use a soldering iron instead of a hobby knife to cut the covering from the stab. The tip of the soldering iron doesn't have to be sharp, but a fine tip does work best. Allow the iron to heat fully. Use a straightedge to guide the soldering iron at a rate that will just melt the covering and not burn into the wood. The hotter the soldering iron, the faster it must travel to melt a fine cut. Peel off the covering.



○ 12. Locate the **wing belly pan**. Cut the covering away from the holes at the rear of the belly pan.

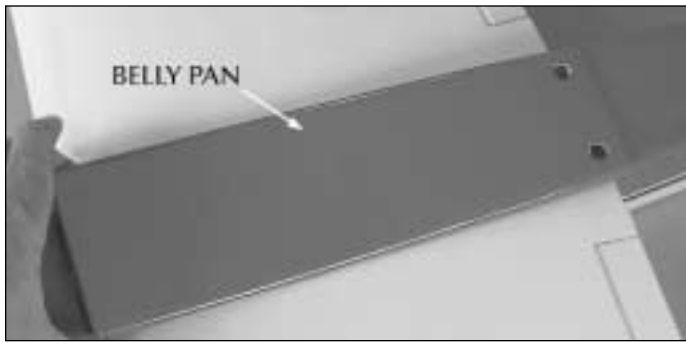

○ 13. Place the belly pan in position on the wing, aligning it with the fuselage. Trace the outline of the belly pan onto the wing with a felt-tip marker.

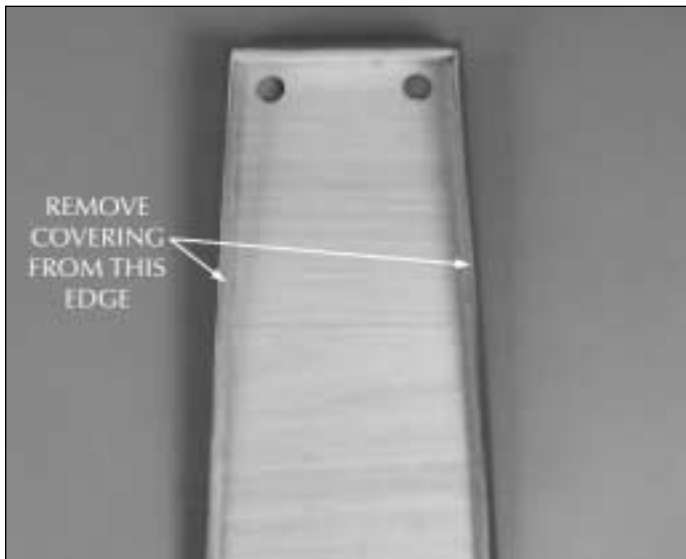

○ 14. Remove the covering from the edge of the inside of the belly pan. This is most easily done by carefully sanding the edge with a sanding block. Be careful to only sand it as much as needed to remove the covering.



○ 15. Glue the belly pan in place on the wing, making sure it is aligned with the fuselage. Once the glue has cured, remove the wing from the fuselage.

INSTALL THE MAIN LANDING GEAR



○ 1. Cut the covering away from the landing gear blocks on both wing panels.

○ 2. Insert the **landing gear wires** into the holes in the landing gear blocks. (The short end of the wire is the end that is inserted into the landing gear block). Do this for both wings.



○ 3. Locate two nylon landing gear straps and four 2 x 10mm sheet metal screws. Locate the nylon landing gear straps over the landing gear wire. Mark the location for the holes, then drill a 1/16" [1.6mm] hole into the landing gear blocks. Install

the nylon landing gear straps with two sheet metal screws. Follow this procedure for the remaining landing gear wire.



○ 4. File a flat spot on the end of the landing gear wire.



○ 5. Locate two 4mm wheel collars, two 3 x 5mm set screws and one foam **wheel**. Install one wheel collar and set screw onto the landing gear wire followed by the wheel and another wheel collar and set screw. Tighten the wheel collar set screws onto the landing gear wire, making sure the set screw on the outer wheel collar is tightened against the flat spot you filed on the wire. Be sure to use a small amount of threadlocker on the set screws. Do the same for the other landing gear. Apply a drop of oil on the wheels.

INSTALL THE AILERON SERVO



○ 1. Install your servo into the servo compartment following the instructions included with your particular brand of servo. Install the servo arm in the orientation shown. Drill 1/16" [1.6mm] pilot holes for the servo screws. Remove the servo. Then, install and remove a servo screw into each of the holes. Put a couple of drops of thin CA into each of the holes and

allow the glue to cure. Permanently install the servo using the screws provided with the servos.



○ 2. Locate two nylon **aileron torque rod links**. Thread them onto the aileron torque rods approximately 20 full turns.

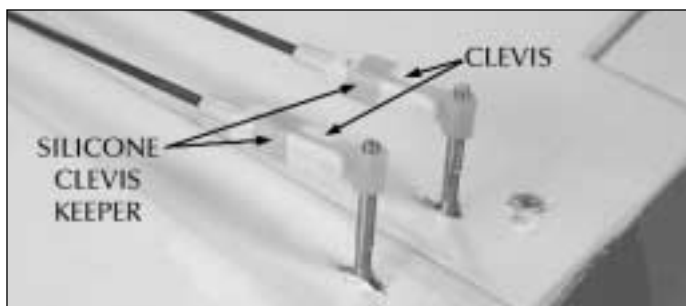

○ 3. Locate the two 6" [152mm] **aileron pushrod wires**. Install a nylon **clevis** onto the threaded end of the wire approximately 20 turns. Then, slide a silicone clevis keeper onto the wire. Install the clevis onto the nylon torque rod link and lock it in place by sliding the silicone clevis keeper over the clevis.

○ 4. Be sure the aileron servo is centered. Enlarge the first hole in the servo arm with a Hobbico Servo Horn Drill (HCAR0698) (or a #48 or 5/64" [2mm] drill bit). Center the aileron and align the wire pushrod with the hole in the end of the servo arm. Using a marker, mark the location where the wire aligns with the hole in the servo arm. On that mark make a 90° bend. From the bend measure an additional 3/16" [4.8mm] and then cut off the excess pushrod wire.

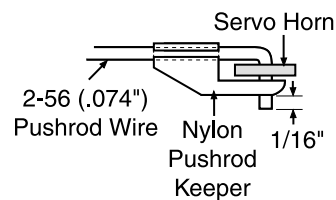

○ 5. Install the wire into the hole in the servo arm using a nylon pushrod keeper as shown in the sketch.

ASSEMBLE THE FUSELAGE

MOUNT THE STAB & FIN

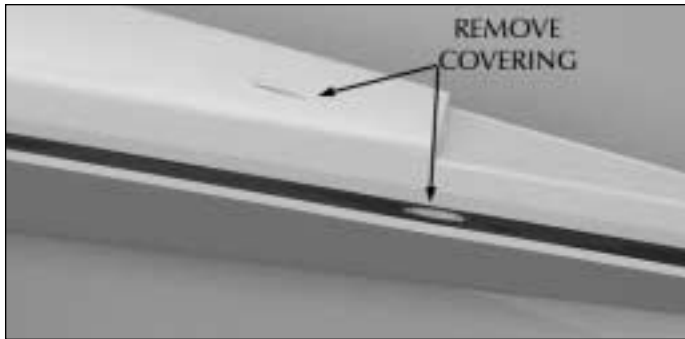

○ 1. Locate the **fuselage**. Cut the covering away from the pushrod exits at the rear of the fuselage. There is one located on the left and right side of the fuselage and one on the top of the fuselage. Cut away the covering to expose the hole in the bottom, front of the fuselage.

○ 2. Bolt the wing to the fuselage. Place the model in a building stand (such as a Robart Super Stand II, ROBQ1402).

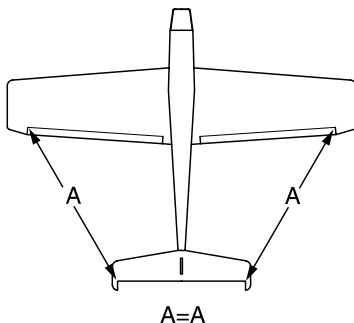
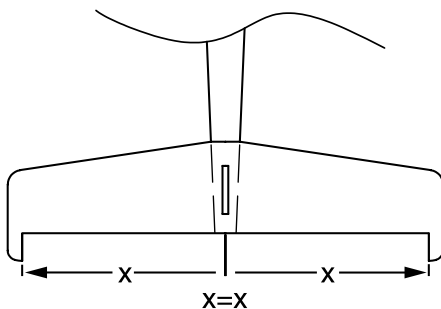

○ 3. Fit the **stab** onto the fuselage. Center the trailing edge by taking accurate measurements as shown. Temporarily hold it

in place with a couple of T-pins. Measure from the wing tip to the stab, adjusting the stab until the distance is equal. Once the stab is positioned properly use a felt-tip marker to mark the outline of the fuselage on the bottom of the stab.

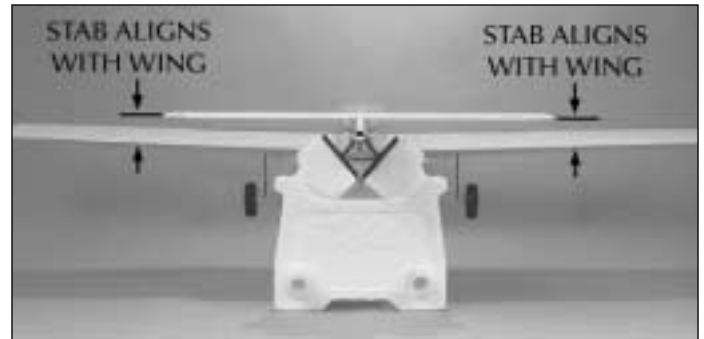

○ 4. Stand five to ten feet [2m] behind the model and view the stab and wing. If the stab and wing align with each other, proceed to the next step. If the stab and wing do not align, remove the stab and sand the high side of the fuselage until the stab aligns with the wing.



○ 5. Carefully cut the covering from the bottom of the stab inside the marks you made on the bottom of the stab. Use the same technique for cutting the covering as you used for the wing.

○ 6. Glue the stab to the fuselage with 6-minute epoxy. Be sure to check the alignment of the stab before the glue cures. Clean any excess epoxy with rubbing alcohol and a paper towel.

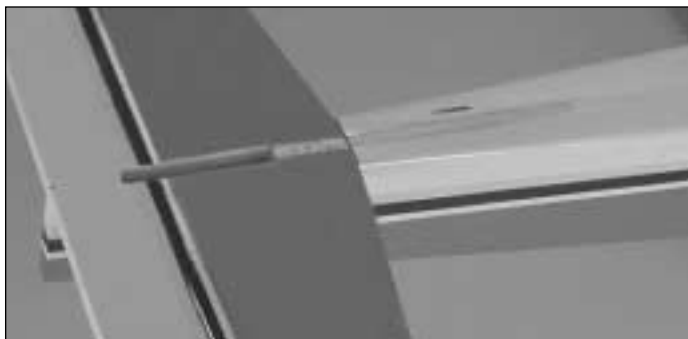

○ 7. Cut the covering away from the fuselage as shown.

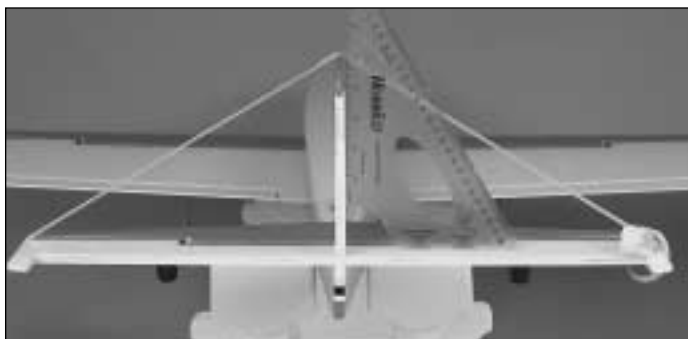

○ 8. Test fit the fin into the slot in the stab. Make adjustments as needed to get a good fit. Once you are satisfied with the fit, glue the fin to the stab with 6-minute epoxy. Use a triangle to make sure the fin is perpendicular to the stab. Hold the fin in place with masking tape until the glue has cured.

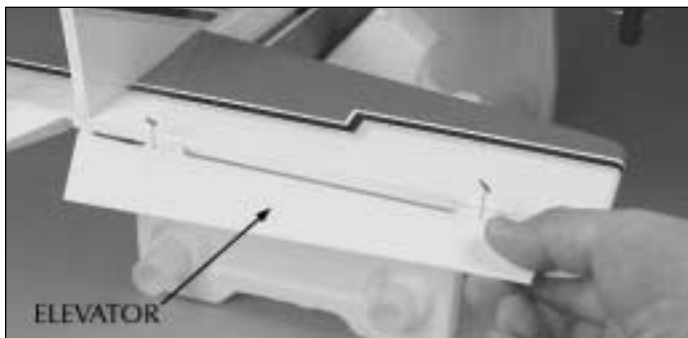

○ 9. Permanently install the elevators to the stab using the same technique used for installing the aileron hinges.

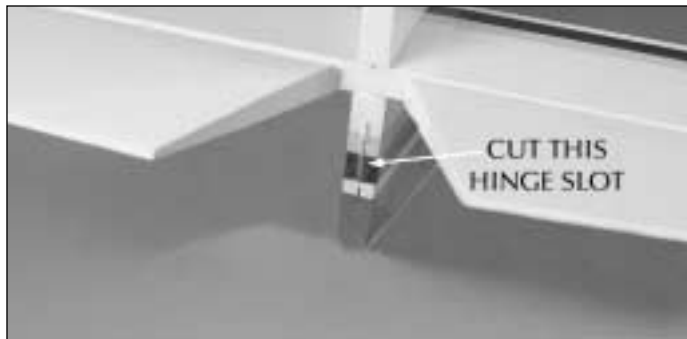

○ 10. Look closely at the trailing edge of the rudder. You will find three pre-cut hinge slots. Look at the fin and you will see that there are two pre-cut hinge slots in the fin. Position the rudder against the fin, aligning the hinge slots. The lower hinge on the rudder does not have a matching slot on the bottom of the fuselage. Mark the location for the hinge slot on the bottom of the fuselage. Using a hobby knife, cut a hinge slot where you have marked.

○ 11. Permanently install the rudder to the fin and fuselage using the same technique used for installing the ailerons and elevators.

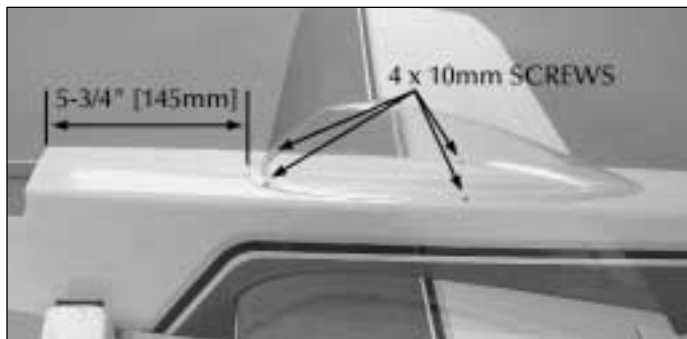

○ 12. Center the canopy on the top of the fuselage 5-3/4" [145mm] back from the engine compartment. Drill two 1/16" [1.6mm] holes on the flange of the canopy on both sides of the canopy. The location of the holes is not crucial but should be positioned towards the front and rear of the canopy flange. Drill through the canopy flange and the fuselage. Remove the canopy, apply a couple of drops of thin CA into each of the four holes and allow it to cure. Once the glue has cured, install the canopy in place with four 2 x 10mm screws with the washer head.

INSTALL THE NOSE GEAR

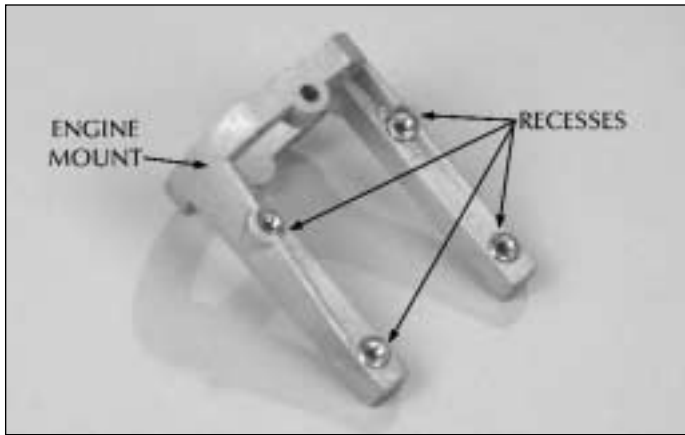

○ 1. Locate the aluminum **engine mount**. Turn the mount over and take notice of the recesses on the bottom of both rails. Locate four 4mm nuts. Test fit the nuts into the recesses in the bottom of the landing gear rails. Once the nuts are properly seated in the rails, carefully apply a small drop of medium CA glue onto the edge of the nuts. Do not apply too much glue; this could cause glue to wick into the threads of the nuts. Allow the glue to cure or apply some CA accelerator to the glue to speed the curing process.



○ 2. Locate the nylon **nose gear block**. Install it onto the firewall using two 4 x 15mm machine screws.



○ 3. Install the engine mount to the firewall with four 4 x 15mm machine screws, 4mm lock washers and 4mm flat washers.



○ 4. Locate one of the two 14" [356mm] white nylon **pushrod tubes**. Roughen one end of the tube with 220-grit sandpaper. Insert the un-sanded end of the tube into the hole in the bottom left side of the firewall. Feed the tube through the fuselage so that it exits inside of the forward fuselage former.

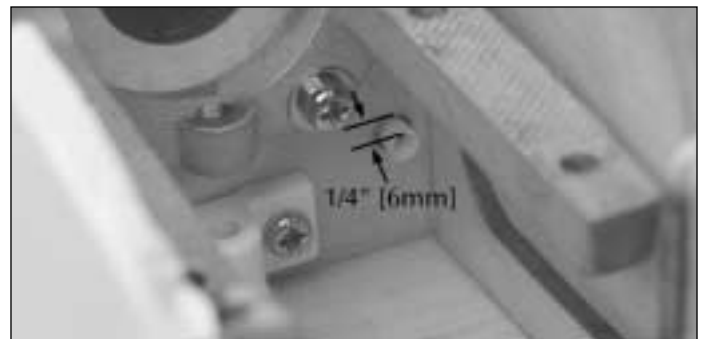

○ 5. Apply a small amount of 6-minute epoxy to the end of the white nylon tube. Position the tube so that it extends beyond the firewall approximately 1/4" [6mm]. Allow the epoxy to cure.



○ 6. Install a 4mm wheel collar into the nylon steering arm. Once the wheel collar is in position install a 3 x 10mm machine screw into the arm and wheel collar.



○ 7. The nylon steering arm has three holes. Cut the end hole from the steering arm. Using a small sanding block, round the end of the arm after cutting off the outermost hole.

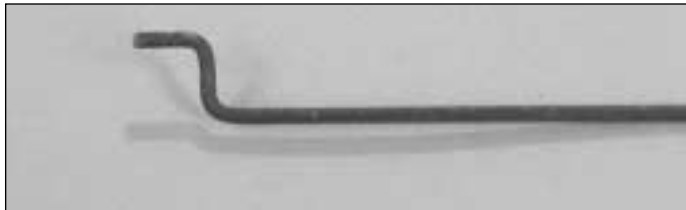

○ 8. Locate the 1.5mm wire with the Z-bend on one end of the wire. Insert it into the outermost hole of the steering arm as shown.

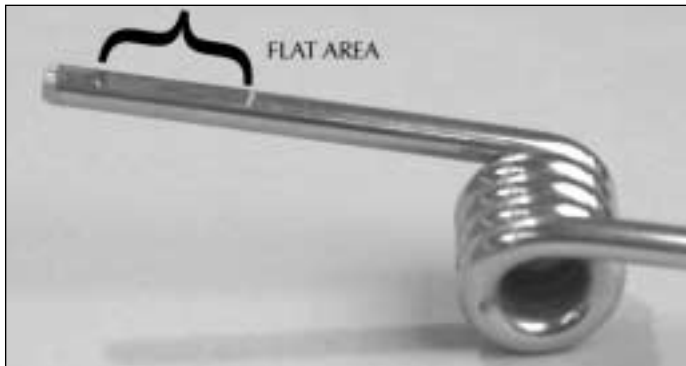

○ 9. Locate the wire nose gear. Notice that there is a flat spot on one side of the wire. Insert the wire through the bottom of the fuselage, through the nylon nose gear bearing, the nylon

steering arm and into the bottom of the engine mount. Apply a drop of threadlocker to the set screw. Then, tighten the set screw in the steering arm onto the flat spot on the landing gear wire.



○ 10. File a flat spot onto the end of the metal nose gear wire.



○ 11. Locate two 4mm wheel collars and two 3 x 5mm set screws. Install the screws into the wheel collars. Slide a wheel collar and set screw onto the nose gear wire, followed by the foam nose wheel and another wheel collar and set screw. Tighten the set screw in the outer wheel collar onto the flat spot you filed on the end of the wire. Center the nose wheel and then tighten the set screw on the remaining wheel collar.

INSTALL THE FUEL TANK & ENGINE

○ 1. Locate the **fuel tank**. Remove the parts from inside of the tank.

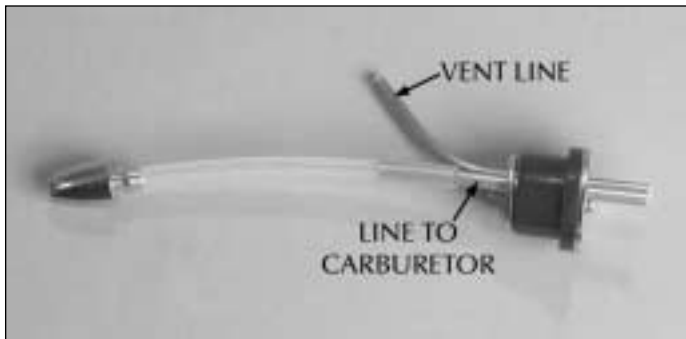

○ 2. Assemble the components. Included in the fuel tank parts are three aluminum tubes. If you will be fueling your plane with a third line rather than filling the tank through the carburetor line, you will need to use the third aluminum tube. If not, assemble the tank as shown with a vent line and carburetor line. Once assembled, use a fine tip marker and mark the front of the fuel tank so you can identify which is the vent line and which is the carburetor line.

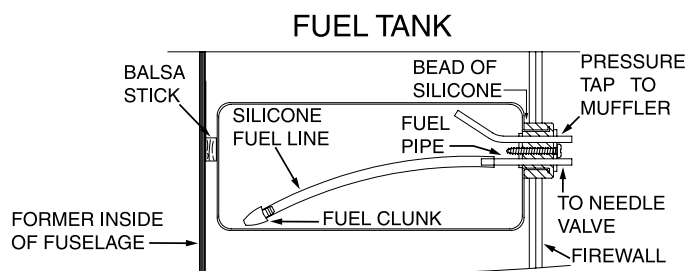

○ 3. Insert the fuel tank into the fuselage. Hold the tank in place either by using silicone glue around the front of the tank or insert a small balsa stick (not supplied) behind the tank and glue the stick to the former.

○ 4. Install fuel tubing on the aluminum lines, long enough to reach the carburetor inlet and the pressure tap on the muffler.

○ 5. Test fit your engine onto the engine mount. Depending on your particular brand of engine and whether it has a remote needle valve you may need to make additional cut-outs or enlarge the cut-outs that are already made in the

engine compartment. Make the necessary adjustments as needed to allow your engine to fit.

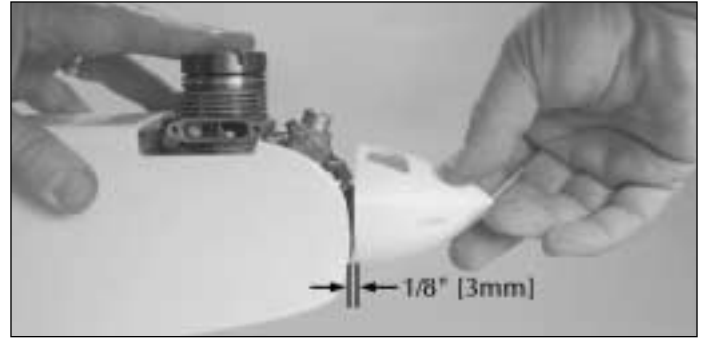

○ 6. Locate the **plastic spinner**. Remove the nut and washer from the engine crankshaft and slide the spinner onto the crankshaft. Place the engine on the engine mount, positioning it so that there is a least 1/8" [3mm] clearance between the back of the spinner and the sides of the fuselage. Remove the spinner.



○ 7. Locate the two engine mounting straps. Install them on the engine and engine mount by inserting a 4 x 25mm machine screw, 4mm lock washer and a 4mm flat washer through the holes in the end of the strap. Attach the strap to the engine mount. Be careful not to push too hard on the nuts you glued in the bottom of the engine mount earlier. Doing so could cause the nuts to fall out of the mount, requiring you to remove the engine mount to replace the nuts.

○ 8. Locate the remaining 14" [356mm] white pushrod tube. Roughen one end of the tube with 220-grit sandpaper. Insert the un-sanded end of the tube into the hole in the top right side of the firewall. Apply a small amount of 6-minute epoxy to the end of the white nylon tube. Position the tube so that it extends beyond the firewall approximately 1/4" [6mm]. Allow the epoxy to cure.



○ 9. Locate the .074 x 16" [406mm] pushrod, threaded on one end. Thread a nylon clevis onto the threaded portion of the rod approximately 20 full turns. Install a silicone clevis keeper onto the bottom of the clevis.



○ 10. Slide the end of the wire into the tube. Attach the clevis to the throttle arm on the carburetor. Slide the clevis keeper over the clevis.

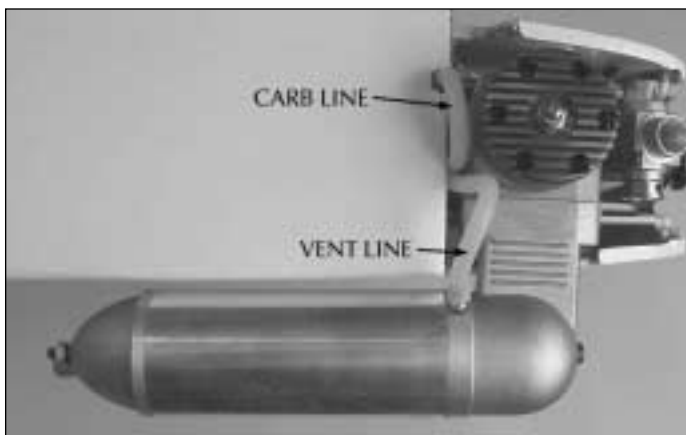

○ 11. Install the muffler. Attach the fuel lines to the carburetor and the muffler pressure tap.

○ 12. Install the appropriate propeller for your engine and the spinner onto the engine crankshaft.

INSTALL THE RADIO & SERVOS

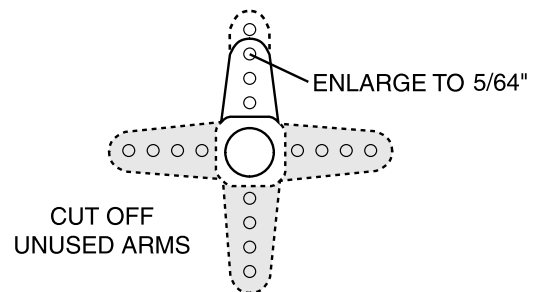
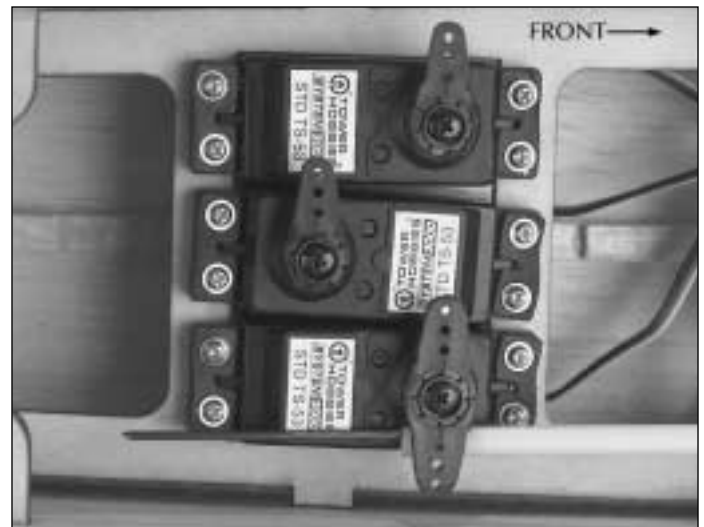

○ 1. Install your servos into the servo bay using the hardware and instructions that came with the servos. Install the servos in the direction shown. You will only need to use a servo arm that has three holes in the arm. If your servo arms have more than 3 holes, cut off the excess holes and shape the end of the arm to a round finish with a sanding block or high-speed rotary tool. Cut off the unused arms. Set them aside as you will be using some of them later.

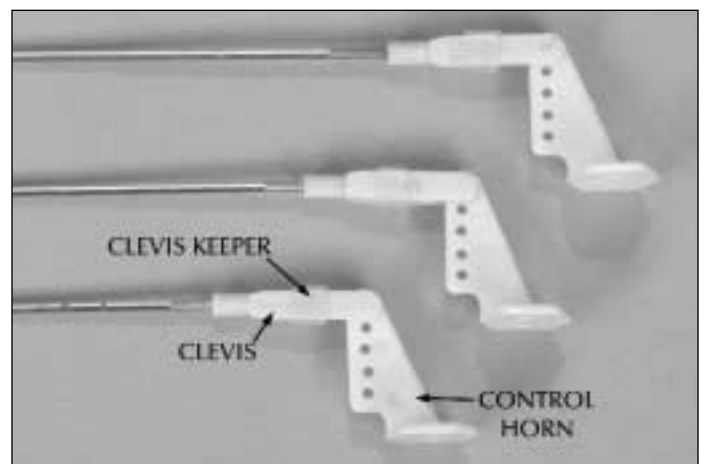

○ 2. Locate the three 2 x 680mm wire pushrods, threaded on one end. Thread a nylon clevis onto the threaded portion of the rod approximately 16 to 20 full turns. Install a silicone clevis keeper onto the bottom of the clevis. Install the clevis into the nylon **control horn**. Once it is securely in place slide

the silicone clevis keeper over the clevis. Repeat this for all three pushrods.

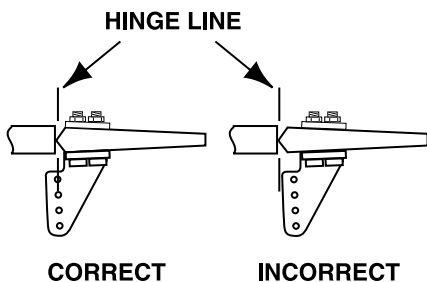

○ 3. Insert the end of the pushrod wire into the hole on the left side of the fuselage. Position the control horn on the elevator half. Once the control horn is properly positioned, use a fine-tip marker to mark the hole locations. Drill a 3/32" [2.4mm] hole through the marks you made on the elevator, drilling all the way through the elevator. Install the control horn to the elevator by inserting a 2 x 15mm machine screw through each of the holes in the control horn and threading them into the control horn plate on the top of the elevator. Repeat this procedure for the other elevator.



○ 4. Insert the remaining pushrod into the hole on the top of the fuselage. Mount the control horn to the rudder following the same procedure used for the elevator.

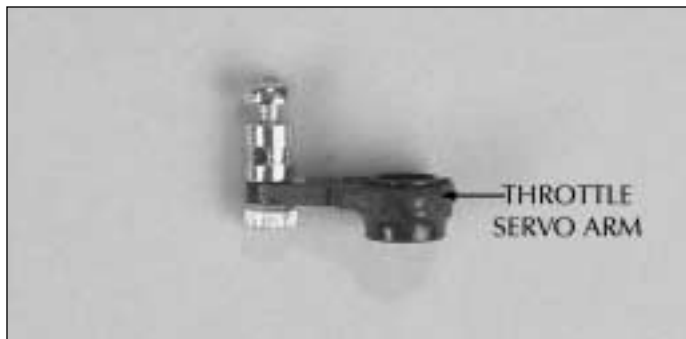
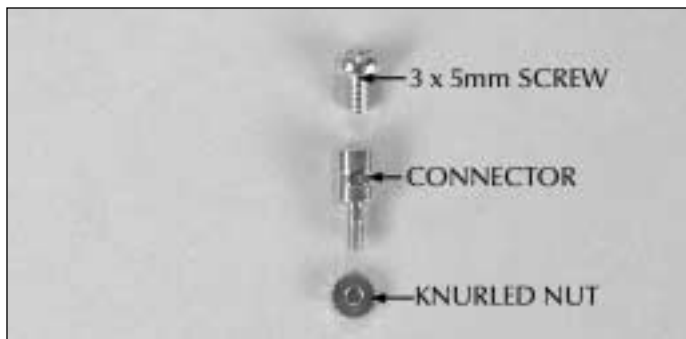

○ 5. Locate the three components of the screw-lock connector: the 3 x 5mm set screw, connector and the knurled nut. Remove the servo arm from your throttle servo. Drill the outermost hole of the servo arm with a 5/64" [2mm] drill bit. Install the connector by inserting the threaded pin into the servo arm. **IMPORTANT!** Place a drop of Threadlocker onto the threads. Install the knurled nut onto the threads but do not tighten it against the servo arm. It is necessary for the connector to be able to rotate in the servo arm hole. If you do not use the thread-locking compound, the nut will come off resulting in the loss of the throttle control.



○ 6. You may find it necessary to shorten the length of the white nylon tube that the throttle pushrod is in. Cut it so that it extends just beyond the former that supports the servo tray. Make a mark on the former at the point where the white nylon tube contacts it. At that point cut a small notch in the former for the tube to rest in. Sand the tube with 220-grit sandpaper where the tube contacts the notch you made in the former. Glue the tube into the notch with 6-minute epoxy.



○ 7. Cut a notch in the former behind the fuel tank for the nose gear steering pushrod tube. Sand the tube with 220-grit sandpaper where the tube rests in the notch you made.



○ 8. Cut a notch in the former that supports the servo tray for the nose gear steering pushrod tube.

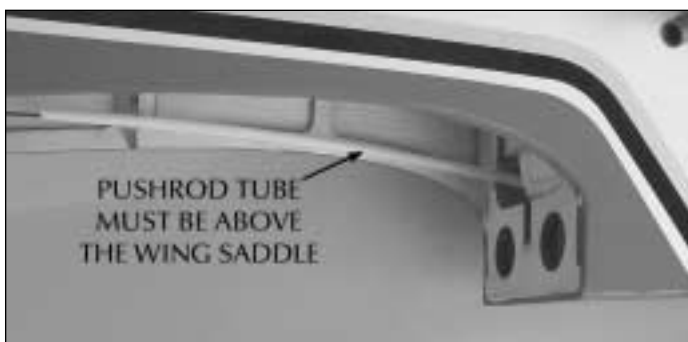

○ 9. Looking at the left side of the inside of the fuselage, you will see that the nose gear steering pushrod tube is slightly lower than the wing saddle. If left like this it could interfere with the wing. Glue the pushrod into the notches you made in the two formers with 6-minute epoxy. When gluing the tubes in place, press on the tube so that it is inside the fuselage. Hold the tube while the glue cures or place a balsa stick across the wing saddle. Tape the stick onto both sides of the fuselage to hold the tube in place.



○ 10. Insert the throttle pushrod into the screw-lock connector. Center the servo and then tighten the set screw against the pushrod wire.

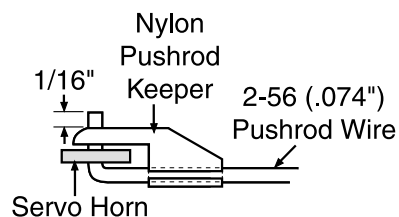

○ 11. Center the rudder. Place the rudder pushrod over the outermost hole in the servo arm. Using a fine-point marker, make a mark on the pushrod where it crosses over the hole in the servo arm. Bend the pushrod 90 degrees on the mark. Cut the pushrod so that it extends 3/8" [9.5mm] above the bend. Drill the outermost hole of the servo arm with a 5/64" [2mm] drill bit. Insert the pushrod into the outermost hole in the servo arm and retain it with a nylon pushrod keeper.

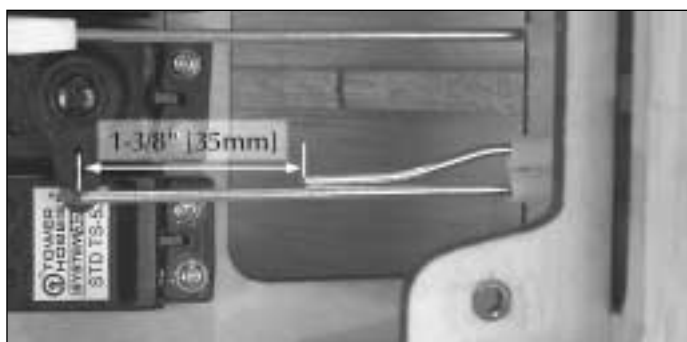

○ 12. Center the elevator servo. Drill the outermost hole of the servo arm with a 5/64" [2mm] drill bit. Center the elevator half that is attached to the pushrod that is in-line with the servo arm. Using a fine-point marker, make a mark on the pushrod where it crosses over the hole in the servo arm. Bend the pushrod 90 degrees on the mark. Cut the pushrod so that it extends 3/8" [9.5mm] above the bend. Center the remaining half of the elevator. Bend the pushrod as shown. Then, cut the pushrod 1-3/8" [35mm] from the bend in the other pushrod.



○ 13. Locate two 4mm wheel collars and two 3 x 5mm set screws. Slide them over both of the elevator pushrods. Center both halves of the elevator. Then, tighten the set screws. Install the wire pushrod into the servo arm, retain the pushrod with a nylon pushrod connector and then install the servo arm onto the servo.



This completes the servo installation. Your final servo installation should match the photograph.

○ 14. Plug the servo leads into the receiver and install the battery switch and charge jack following the instructions provided with your radio system. Be sure to install the switch on the fuselage side opposite the muffler to prevent fuel from getting into the switch.

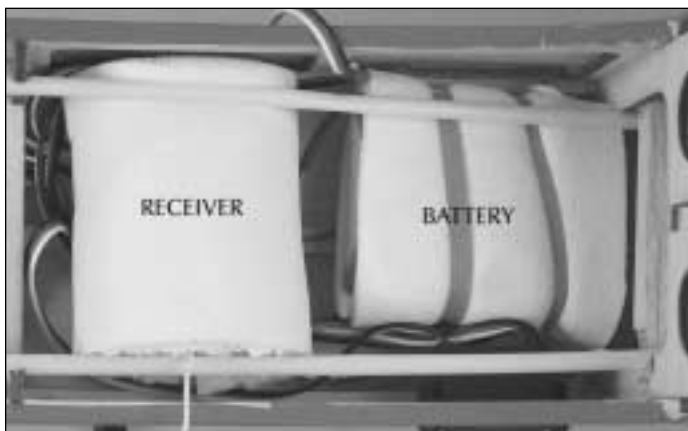

○ 15. Wrap the battery and receiver in 1/4" [6.4mm] thick foam rubber. Place them into the fuselage as shown.

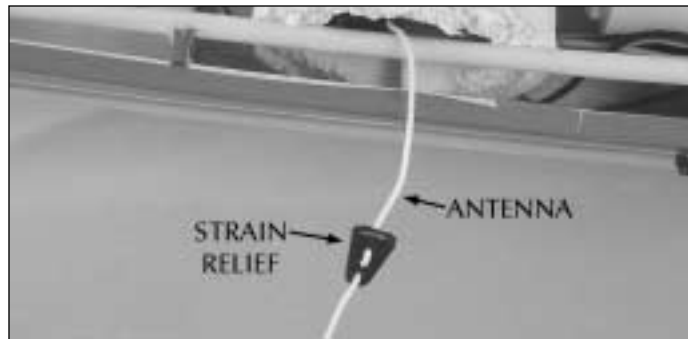

○ 16. Locate one of the discarded servo arms you cut off earlier. You are going to use it as a strain relief for your receiver antenna. Route the antenna through the arm as shown.

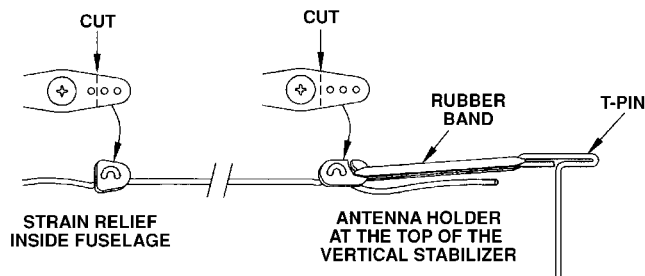

○ 17. Drill a 1/16" [1.6mm] hole in the side of the fuselage. Insert the antenna through the hole, pulling it out of the fuselage. The plastic servo arm should be pulled against the inside of the fuselage.

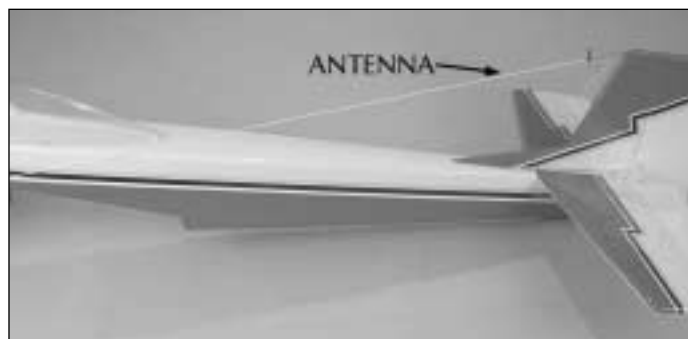

○ 18. Following the illustration at step 17, use another servo arm on the end of the receiver wire. Insert a T-pin into the top of the vertical fin. Attach a rubber band to the antenna and the T-pin.

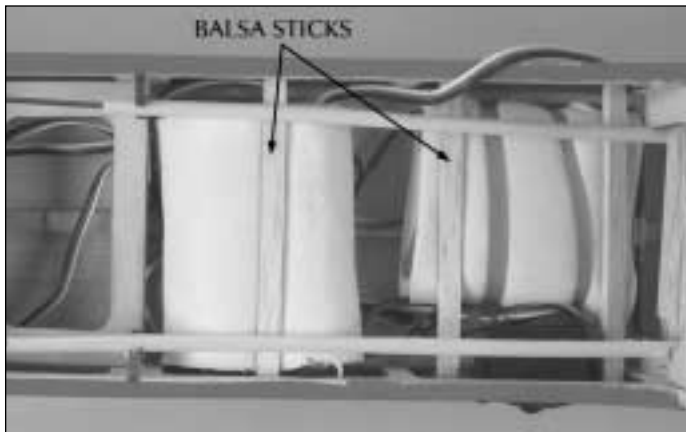

○ 19. Be sure all servo lines are plugged into the receiver. Permanently secure the receiver and battery into the fuselage holding them in place by gluing a couple of balsa sticks (not supplied) into the fuselage.

GET THE MODEL READY TO FLY

CHECK THE CONTROL DIRECTIONS

○ 1. Turn on the transmitter and receiver and center the trims. If necessary, remove the servo arms from the servos and reposition them so they are centered. Reinstall the screws that hold on the servo arms.

○ 2. With the transmitter and receiver still on, check all the control surfaces to see if they are centered. If necessary, adjust the clevises on the pushrods to center the control surfaces.

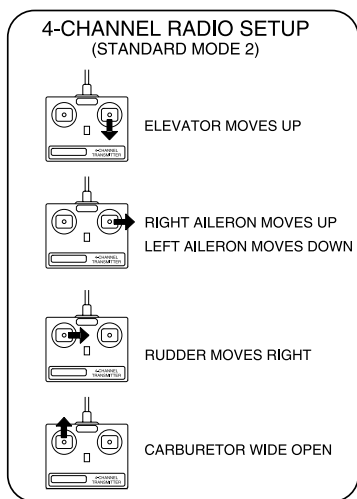

○ 3. Make certain that the control surfaces and the carburetor respond in the correct direction as shown in the diagram. If any of the controls respond in the wrong direction, use the servo reversing in the transmitter to reverse the servos connected to those controls. Be certain the control surfaces have remained centered. Adjust if necessary.

SET THE CONTROL THROWS

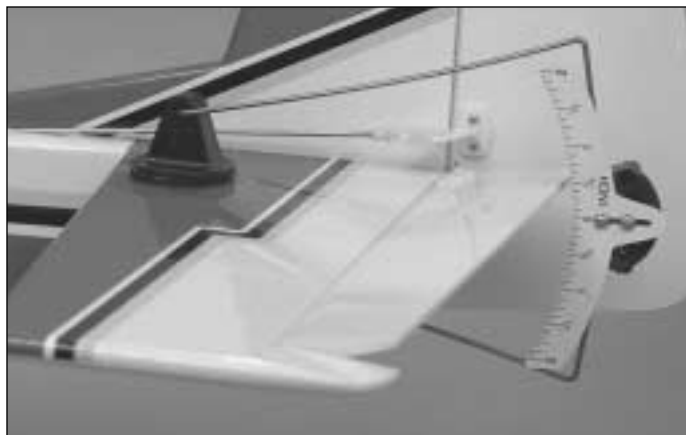

Use a Great Planes AccuThrow (or a ruler) to accurately measure and set the control throw of each control surface as indicated in the chart that follows. If your radio does not have dual rates, we recommend setting the throws at the **low** rate setting.

Note: The throws are measured at the **widest part** of the elevators, rudder and ailerons.

These are the recommended control surface throws:

	High Rate	Low Rate
ELEVATOR:	5/8" [16mm] up 5/8" [16mm] down	3/8" [10mm] up 3/8" [10mm] down
RUDDER:	1" [25mm] left 1" [25mm] right	1/2" [13mm] left 1/2" [13mm] right
AILERONS:	3/8" [10mm] up 3/8" [10mm] down	1/4" [6mm] up 1/4" [6mm] down

IMPORTANT: The Kaos.40 has been **extensively** flown and tested to arrive at the throws at which it flies best. Flying your model at these throws will provide you with the greatest chance for successful first flights. If, after you have become accustomed to the way the Kaos.40 flies, you would like to change the throws to suit your taste, that is fine. However, too much control throw could make the model difficult to control, so remember, "more is not always better."

BALANCE THE MODEL (C.G.)

More than any other factor, the **C.G.** (balance point) can have the **greatest** effect on how a model flies, and may determine whether or not your first flight will be successful. If you value this model and wish to enjoy it for many flights, **DO NOT OVERLOOK THIS IMPORTANT PROCEDURE.** A model that is not properly balanced will be unstable and possibly unflyable.

At this stage the model should be in ready-to-fly condition with all of the systems in place including the engine, landing gear, covering, and the radio system.

- 1. Use a felt-tip pen or 1/8" [3mm]-wide tape to accurately mark the C.G. on the top of the wing on both sides of the fuselage. The C.G. is located 3-1/8" [80mm] back from the leading edge of the wing, where it meets the fuselage.

This is where your model should balance for the first flights. Later, you may wish to experiment by shifting the C.G. up to 1/8" [3mm] forward or 7/8" [22mm] back to change the flying characteristics. Moving the C.G. forward may improve the smoothness and stability, but the model may then require more speed for takeoff and make it more difficult to slow for landing. Moving the C.G. aft makes the model more maneuverable, but could also cause it to become too difficult to control. In any case, **start at the recommended balance point** and do not at any time balance the model outside the specified range.

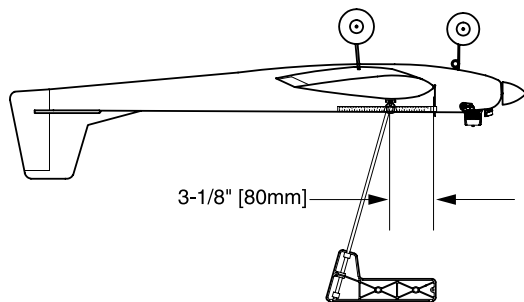

- 2. With the wing attached to the fuselage, all parts of the model installed (ready-to-fly) and an empty fuel tank, place the model upside-down on a Great Planes CG Machine, or lift it upside-down at the balance point you marked.

- 3. If the tail drops, the model is "tail heavy" and weight must be added to the nose to balance. If the nose drops, the model is "nose heavy" and weight must be added to the tail to balance. If additional weight is required, nose weight may be easily added by using a "spinner weight" (GPMQ4645 for the 1 oz. weight, or GPMQ4646 for the 2 oz. weight). If spinner weight is not practical or is not enough, use Great Planes (GPMQ4485) "stick-on" lead. A good place to add stick-on nose weight is to the firewall (don't attach weight to the cowl—it is not intended to support weight). Begin by placing incrementally increasing amounts of weight on the fuse over the firewall until the model balances. Once you have determined the amount of weight required, it can be permanently attached. If required, tail weight may be added by cutting open the bottom of the fuse and gluing it permanently inside.

Note: Do not rely upon the adhesive on the back of the lead weight to permanently hold it in place. Over time, fuel and exhaust residue may soften the adhesive and cause the weight to fall off. Use #2 sheet metal screws, RTV silicone or epoxy to permanently hold the weight in place.

- 4. **IMPORTANT:** If you found it necessary to add any weight, recheck the C.G. after the weight has been installed.

BALANCE THE MODEL Laterally

- 1. With the wing level, have an assistant help you lift the model by the engine propeller shaft and the bottom of the fuse under the TE of the fin. Do this several times.

- 2. If one wing always drops when you lift the model, it means that side is heavy. Balance the airplane by adding weight to the other wing tip. **An airplane that has been laterally balanced will track better in loops and other maneuvers.**

PREFLIGHT

IDENTIFY YOUR MODEL

No matter if you fly at an AMA sanctioned R/C club site or if you fly somewhere on your own, you should always have your name, address, telephone number and AMA number on or inside your model. It is **required** at all AMA R/C club flying sites and AMA sanctioned flying events. Fill out the identification tag on page 23 and place it on or inside your model.

CHARGE THE BATTERIES

Follow the battery charging instructions that came with your radio control system to charge the batteries. You should always charge your transmitter and receiver batteries the night before you go flying, and at other times as recommended by the radio manufacturer.

Note: Checking the condition of your receiver battery pack is **highly recommended**. All battery packs, whether it's a trusty pack you've just taken out of another model, or a new battery pack you just purchased, should be cycled, noting the discharge capacity. Oftentimes, a weak battery pack can be identified (and a valuable model saved!) by comparing its actual capacity to its rated capacity. Refer to the instructions and recommendations that come with your cycler. If you don't own a battery cycler, perhaps you can have a friend cycle your pack and note the capacity for you.

BALANCE THE PROPELLERS

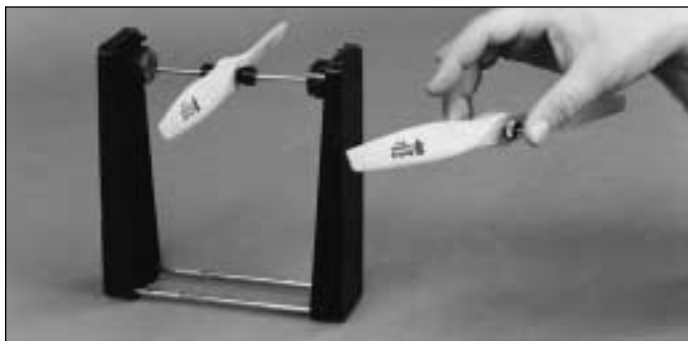

Carefully balance your propeller and spare propellers before you fly. An unbalanced prop can be the single most significant cause of vibration that can damage your model. Not only will engine mounting screws and bolts loosen, possibly with disastrous effect, but vibration may also damage your radio receiver and battery. Vibration can also cause your fuel to foam, which will, in turn, cause your engine to run hot or quit.

We use a Top Flite Precision Magnetic Prop Balancer™ (TOPQ5700) in the workshop and keep a Great Planes Fingertip Prop Balancer (GPMQ5000) in our flight box.

GROUND CHECK

If the engine is new, follow the engine manufacturer's instructions to break-in the engine. After break-in, confirm that the engine idles reliably, transitions smoothly and rapidly to full power and maintains full power—indefinitely. After you run the engine on the model, inspect the model closely to make sure all screws remained tight, the hinges are secure, the prop is secure and all pushrods and connectors are secure.

RANGE CHECK

Ground check the operational range of your radio before the first flight of the day. With the transmitter antenna collapsed and the receiver and transmitter on, you should be able to walk at least 100 feet [30m] away from the model and still have control. Have an assistant stand by your model and, while you work the controls, tell you what the control surfaces are doing. Repeat this test **with the engine running** at various speeds with an assistant holding the model, using hand signals to show you what is happening. If the control surfaces do not respond correctly, **do not fly!** Find and correct the problem first. Look for loose servo connections or broken wires, corroded wires on old servo connectors, poor solder joints in your battery pack or a defective cell, or a damaged receiver crystal from a previous crash.

ENGINE SAFETY PRECAUTIONS

Failure to follow these safety precautions may result in severe injury to yourself and others.

Keep all engine fuel in a safe place, away from high heat, sparks or flames, as fuel is very flammable. Do not smoke near the engine or fuel; and remember that engine exhaust gives off a great deal of deadly carbon monoxide. Therefore, **do not run the engine in a closed room or garage.**

Get help from an experienced pilot when learning to operate engines.

Use safety glasses when starting or running engines.

Do not run the engine in an area of loose gravel or sand; the propeller may throw such material in your face or eyes.

Keep your face and body as well as all spectators away from the plane of rotation of the propeller as you start and run the engine.

Keep these items away from the prop: loose clothing, shirt sleeves, ties, scarfs, long hair or loose objects such as pencils or screwdrivers that may fall out of shirt or jacket pockets into the prop.

Use a “chicken stick” or electric starter to start the engine. Do not use your fingers to flip the propeller. Make certain the glow plug clip or connector is secure so that it will not pop off or otherwise get into the running propeller.

Make all engine adjustments from behind the rotating propeller.

The engine gets hot! Do not touch it during or right after operation. Make sure fuel lines are in good condition so fuel will not leak onto a hot engine, causing a fire.

To stop a glow engine, cut off the fuel supply by closing off the fuel line or following the engine manufacturer's recommendations. Do not use hands, fingers or any other body part to try to stop the engine. To stop a gasoline powered engine an on/off switch should be connected to the engine coil. Do not throw anything into the propeller of a running engine.

AMA SAFETY CODE (excerpt)

Read and abide by the following Academy of Model Aeronautics Official Safety Code:

GENERAL

1. I will not fly my model aircraft in sanctioned events, air shows, or model flying demonstrations until it has been

proven to be airworthy by having been previously successfully flight tested.

2. I will not fly my model aircraft higher than approximately 400 feet within 3 miles of an airport without notifying the airport operator. I will give right of way to, and avoid flying in the proximity of full-scale aircraft. Where necessary an observer shall be used to supervise flying to avoid having models fly in the proximity of full-scale aircraft.

3. Where established, I will abide by the safety rules for the flying site I use, and I will not willfully and deliberately fly my models in a careless, reckless and/or dangerous manner.

7. I will not fly my model unless it is identified with my name and address or AMA number, on or in the model.

9. I will not operate models with pyrotechnics (any device that explodes, burns, or propels a projectile of any kind).

RADIO CONTROL

1. I will have completed a successful radio equipment ground check before the first flight of a new or repaired model.

2. I will not fly my model aircraft in the presence of spectators until I become a qualified flier, unless assisted by an experienced helper.

3. I will perform my initial turn after takeoff away from the pit or spectator areas, and I will not thereafter fly over pit or spectator areas, unless beyond my control.

4. I will operate my model using only radio control frequencies currently allowed by the Federal Communications Commission.

CHECK LIST

During the last few moments of preparation your mind may be elsewhere anticipating the excitement of the first flight. Because of this, you may be more likely to overlook certain checks and procedures that should be performed before the model is flown. To help avoid this, a check list is provided to make sure these important areas are not overlooked. Many are covered in the instruction manual, so where appropriate, refer to the manual for complete instructions. Be sure to check the items off as they are completed (that's why it's called a *check list!*).

- 1. Fuelproof all areas exposed to fuel or exhaust residue.
- 2. Check the C.G. according to the measurements provided in the manual.
- 3. Be certain the battery and receiver are securely mounted in the fuse. Simply stuffing them into place with foam rubber is not sufficient.

- 4. Extend your receiver antenna and make sure it has a strain relief inside the fuselage to keep tension off the solder joint inside the receiver.
- 5. Balance your model *laterally* as explained in the instructions.
- 6. Use thread-locking compound to secure critical fasteners such as the set screws that hold the wheel axles to the struts, screws that hold the carburetor arm (if applicable), screw-lock pushrod connectors, etc.
- 7. Add a drop of oil to the axles so the wheels will turn freely.
- 8. Make sure all hinges are **securely** glued in place.
- 9. Reinforce holes for wood screws with thin CA where appropriate (servo mounting screws, cowl mounting screws, etc.).
- 10. Confirm that all controls operate in the correct direction and the throws are set up according to the manual.
- 11. Make sure there are silicone retainers on all the clevises and that all servo arms are secured to the servos with the screws included with your radio.
- 12. Secure connections between servo wires and Y-connectors or servo extensions, and the connection between your battery pack and the on/off switch with vinyl tape, heat shrink tubing or special clips suitable for that purpose.
- 13. Make sure any servo extension cords you may have used do not interfere with other systems (servo arms, pushrods, etc.).
- 14. Secure the pressure tap (if used) to the muffler with high temp RTV silicone, thread-locking compound or J.B. Weld.
- 15. Make sure the fuel lines are connected and are not kinked.
- 16. Balance your propeller (and spare propellers).
- 17. Tighten the propeller nut and spinner.
- 18. Place your name, address, AMA number and telephone number on or inside your model.
- 19. Cycle your receiver battery pack (if necessary) and make sure it is fully charged.
- 20. If you wish to photograph your model, do so before your first flight.
- 21. Range check your radio when you get to the flying field.

FLYING

The Kaos .40 is a great-flying model that flies smoothly and predictably. The Kaos .40 does not, however, possess the self-recovery characteristics of a primary R/C trainer and should be flown only by experienced R/C pilots.

CAUTION (THIS APPLIES TO ALL R/C AIRPLANES): If, while flying, you notice any unusual sounds, such as a low-pitched “buzz,” this may indicate control surface *flutter*. Because flutter can quickly destroy components of your airplane, any time you detect flutter you must **immediately** cut the throttle and land the airplane! Check all servo grommets for deterioration (this may indicate which surface fluttered), and make sure all pushrod linkages are secure and free of play. If the control surface fluttered once, it probably will flutter again under similar circumstances unless you can eliminate the free-play or flexing in the linkages. Here are some things which can cause flutter: Excessive hinge gap; Not mounting control horns solidly; Poor fit of clevis pin in horn; Side-play of pushrod in guide tube caused by tight bends; Poor fit of Z-bend in servo arm; Insufficient glue used when gluing in the elevator joiner wire; Excessive *play* or *backlash* in servo gears; and Insecure servo mounting.

TAKEOFF

Before you get ready to takeoff, see how the model handles on the ground by doing a few practice runs at **low speeds** on the runway. If necessary, adjust the nose wheel so the model will roll straight down the runway. If you need to calm your nerves before the maiden flight, shut the engine down and bring the model back into the pits. Top off the fuel, then check all fasteners and control linkages for peace of mind.

Remember to takeoff into the wind. When you’re ready, point the model straight down the runway and then gradually advance the throttle. Gain as much speed as your runway and flying site will practically allow before gently applying up elevator, lifting the model into the air. At this moment it is likely that you will need to apply more right rudder to counteract engine torque. Be smooth on the elevator stick, allowing the model to establish a **gentle** climb to a safe altitude before turning into the traffic pattern.

FLIGHT

For reassurance and to keep an eye on other traffic, it is a good idea to have an assistant on the flight line with you. Tell him to remind you to throttle back once the plane gets to a comfortable altitude. While full throttle is usually desirable for takeoff, most models fly more smoothly at reduced speeds.

Take it easy with the Kaos for the first few flights, gradually getting acquainted with it as you gain confidence. Adjust the trims to maintain straight and level flight. After flying around for a while, and while still at a safe altitude with plenty of fuel, practice slow flight and execute practice landing approaches by reducing the throttle to see how the model handles at slower speeds. Add power to see how she climbs as well. Continue to fly around, executing various maneuvers and making mental notes (or having your assistant write them down) of what trim or C.G. changes may be required to fine tune the model so it flies the way you like. Mind your fuel

level, but use this first flight to become familiar with your model before landing.

LANDING

To initiate a landing approach, lower the throttle while on the downwind leg. Allow the nose of the model to pitch downward to gradually bleed off altitude. Continue to lose altitude, but maintain airspeed by keeping the nose down as you turn onto the crosswind leg. Make your final turn toward the runway (into the wind) keeping the nose down to maintain airspeed and control. Level the attitude when the model reaches the runway threshold, modulating the throttle as necessary to maintain your glide path and airspeed. If you are going to overshoot, smoothly advance the throttle (always ready on the right rudder to counteract torque) and climb out to make another attempt. When you’re ready to make your landing flare and the model is a foot or so off the deck, smoothly increase up elevator until it gently touches down.

One final note about flying your model. Have a goal or flight plan in mind for every flight. This can be learning a new maneuver(s), improving a maneuver(s) you already know, or learning how the model behaves in certain conditions (such as on high or low rates). This is not necessarily to improve your skills (*though it is never a bad idea!*), but more importantly so you do not surprise yourself by impulsively attempting a maneuver and suddenly finding that you’ve run out of time, altitude or airspeed. Every maneuver should be deliberate, not impulsive. For example, if you’re going to do a loop, check your altitude, mind the wind direction (anticipating rudder corrections that will be required to maintain heading), remember to throttle back at the top, and make certain you are on the desired rates (high/low rates). A flight plan greatly reduces the chances of crashing your model just because of poor planning and impulsive moves.

Remember to think.

Have a ball! But always stay in control and fly in a safe manner.

GOOD LUCK AND GREAT FLYING!

This model belongs to:

Name

Address

City, State Zip

Phone number

AMA number

